

Test Report



498-2, Geumeo-ro, Pogok-eup, Cheoin-gu,
Yongin-si, Gyeonggi-do, Republic of Korea
TEL. +82-31-338-8837 FAX. +82-31-338-8847

Report No. :
MOV-19-EMC-I035
Page(1)/(39)Pages

1. Customer

- Company : Bullsone
- Address : #2302,M,32,Songdogwahak-ro,Yeonsu-gu,Incheon,21984, Korea
- Date of receipt : 2019-01-14
- Contact Person : Ju Youn Lee
- E-mail : juyoun.lee@bullsone.com
- Tel/Fax : +82-70-4309-4298 / +82-32-209-8475

2. Use of report : Evaluation of EMC test

3. Equipment Under Test

- Product name : Air therapy smartaction
- Model number : Bullsone air therapy smartaction

4. Date of test : 2019-01-15 ~ 2019-01-24

5. Test method used : EN50498:2010

6. Test results

- Refer to Section 3 (Page 18)

Affirmation	Tested by Name : Woo Ram Han 한우람	Technical manager Name : Hyung Kook Lee 이흥국
-------------	--	---

2019-02-01

MOVON Corporation

MOVON CORPORATION

Test Report No.: MOV-19-EMC-I035

Report History

Revision	Date	Description
-	2019-02-01	Initial release



Table of Contents

1	General Information	4
1.1	Notes	4
1.2	Testing Laboratory	4
2	Applicant Information	5
2.1	EUT Details.....	5
2.2	Test mode and Condition.....	5
2.3	Peripheral Equipment	5
2.4	Cable list.....	5
2.5	Test System Layout.....	6
2.6	Classification of functional status	7
2.7	Photo Documentation of the EUT	8
3	Test summary and results	18
3.1	Radiated Emissions (ALSE)	18
3.2	Conducted Transient Immunity.....	29
3.3	Conducted Transient Emission	32
APPENDIX	36
A.	Conducted Transient Immunity	36
B.	Conducted Transient Emission	38

MOVON CORPORATION

Test Report No.: MOV-19-EMC-I035

1 General Information

1.1 Notes

The test results of this test report relate exclusively to the test item specified in 2.2. The MOVON CORP. does not assume responsibility for any conclusions and generalisations drawn from the test results with regard to other specimens or samples of the type of the equipment represented by the test item. The test report may only be reproduced or published in full. Reproduction or publication of extracts from the report requires the prior written approval of the MOVON CORP.

1.2 Testing Laboratory

Test Location :
MOVON CORPORATION.

◆Yongin Laboratory

P. O. box 17030

Address :

498-2, Geumeo-ro, Pogok-eup, Cheoin-gu, Yongin-si, Gyeonggi-do, Republic of Korea

494, Geumeo-ro, Pogok-eup, Cheoin-gu, Yongin-si, Gyeonggi-do, Republic of Korea

Tel : +82-31-338-8837

Fax : +82-31-338-8847

E-mail : emclab@movon.co.kr

Internet : <http://www.movonlab.co.kr>

MOVON CORPORATION

Test Report No.: MOV-19-EMC-I035

2 Applicant Information

2.1 EUT Details

Product name	Air therapy smartaction
Model number	Bullstone air therapy smartaction
Variant model name	N/A
Serial number	N/A
Power supply	DC 12 V
Internal Clock Freq	-
Manufacture	UIL 869-26, Bogwang-ro, Gwangtan-myeon, Paju-si, Gyenggi-do, Korea

2.2 Test mode and Condition

Test mode	Normal Operation Mode
Test voltage	DC 12 V

2.3 Peripheral Equipment

Test set-up of EUT

Description	Model	Serial No.	Manufacturer
Air therapy smartaction	Bullstone air therapy smartaction	None	UIL
Cigar jack	None	None	None
DC Power Supply	SDP 30-20D	3020DLA002	SMtechno

Component parts of EUT

Description	Model	Serial No.	Manufacturer
Main Board	Smart_Action_ver2	None	None
Sub Board1	None	None	None
Sub Board2	RIGHT PCB	None	None
Sub Board3	LEFT PCB	None	None
DC FAN	None	None	None

2.4 Cable list

Start		END		Cable Spec.		
Name	I/O Port	Name	I/O Port	Length(m)	Shield	Core
EUT	DC IN	EUT(Cigar jack)	DC OUT	1.5	Unshielded	N
EUT(Cigar jack)	DC IN	DC Power Supply	DC OUT	2.0	Unshielded	N

2.5 Test System Layout

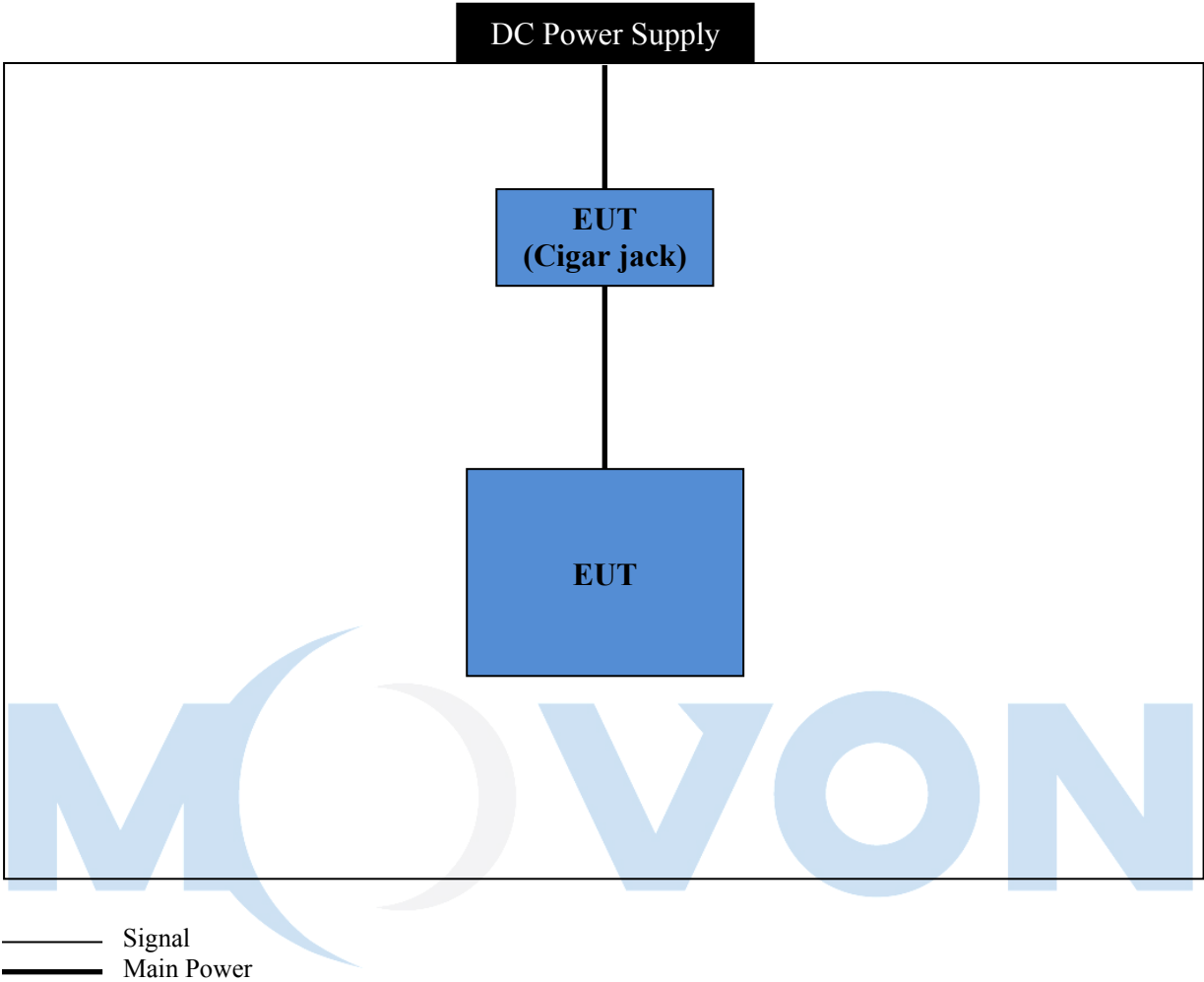

2.6 Classification of functional status

Class	Explanation
A	All functions of a device/system perform as designed during and after exposure to disturbance.
B	All functions of a device/system perform as designed during exposure. However, one or more of them can go beyond specified tolerance. All functions return automatically to within normal limits after exposure is removed. Memory functions shall remain class A.
C	One or more functions of a device/system do not perform as designed during exposure but return automatically to normal operation after exposure is removed.
D	One or more functions of a device/system do not perform as designed during exposure and do not return to normal operation until exposure is removed and the device/system is reset by simple "operator/use" action.
E	One or more functions of a device/system do not perform as designed during and after exposure and cannot be returned to proper operation without repairing or replacing the device/system.



2.7 Photo Documentation of the EUT

2.7.1 EUT Front



2.7.2 EUT Rear



MOVON CORPORATION

Test Report No.: MOV-19-EMC-I035

2.7.3 EUT Right



2.7.4 EUT Left

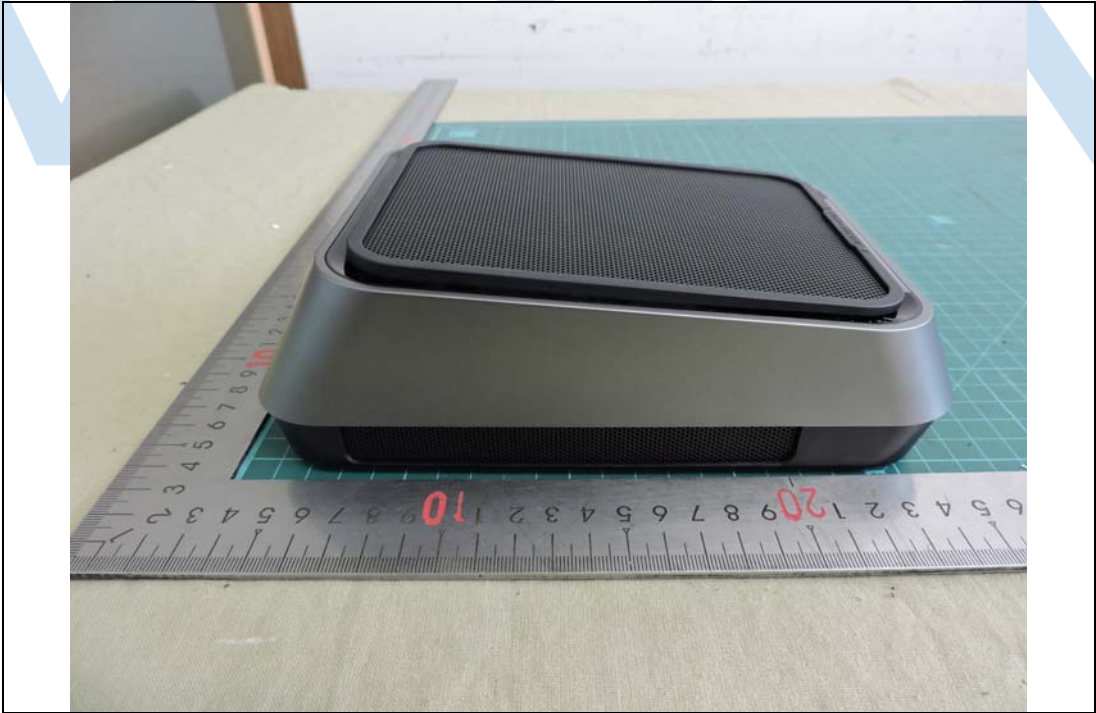

MOVON CORPORATION

Test Report No.: MOV-19-EMC-I035

2.7.5 EUT Top



2.7.6 EUT Bottom



2.7.7 EUT Inside



2.7.8 EUT Main Board Top

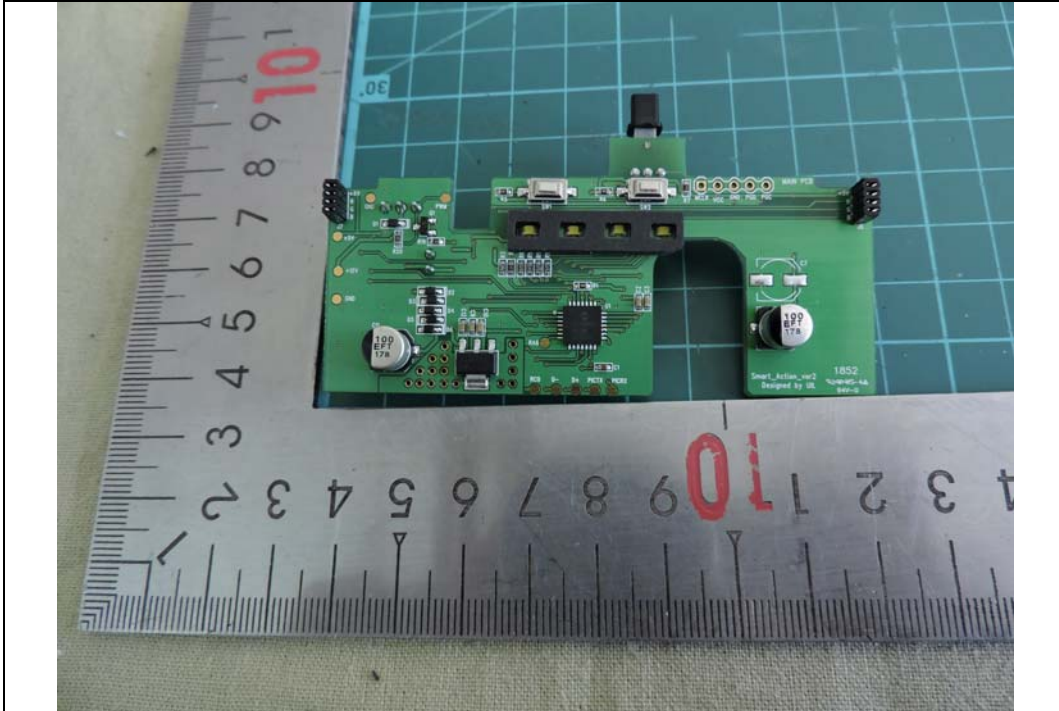

2.7.9 EUT Main Board Bottom

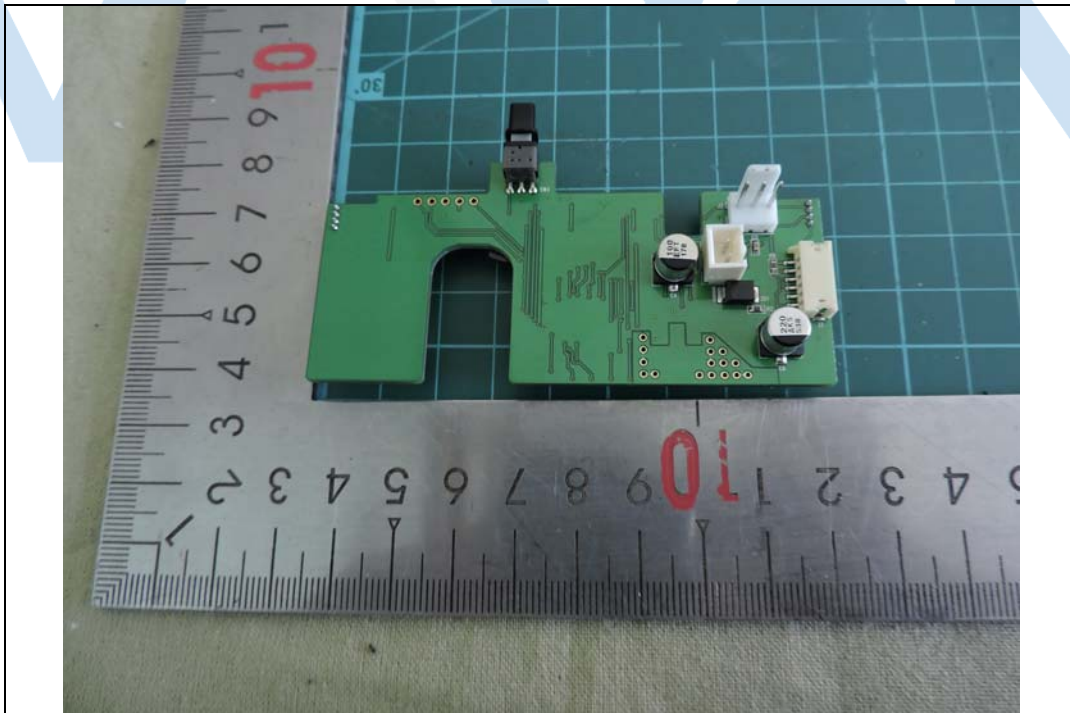

2.7.10 EUT Sub Board1 Top



2.7.11 EUT Sub Board1 Bottom



MOVON CORPORATION

Test Report No.: MOV-19-EMC-I035

2.7.12 EUT Sub Board2 Top

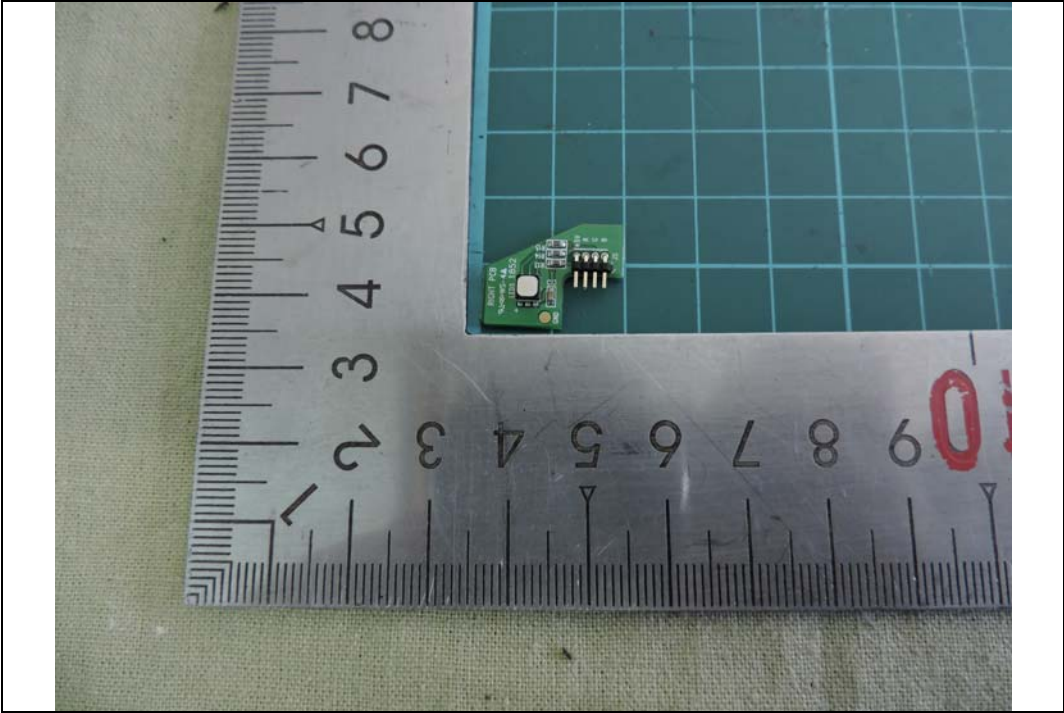

2.7.13 EUT Sub Board2 Bottom

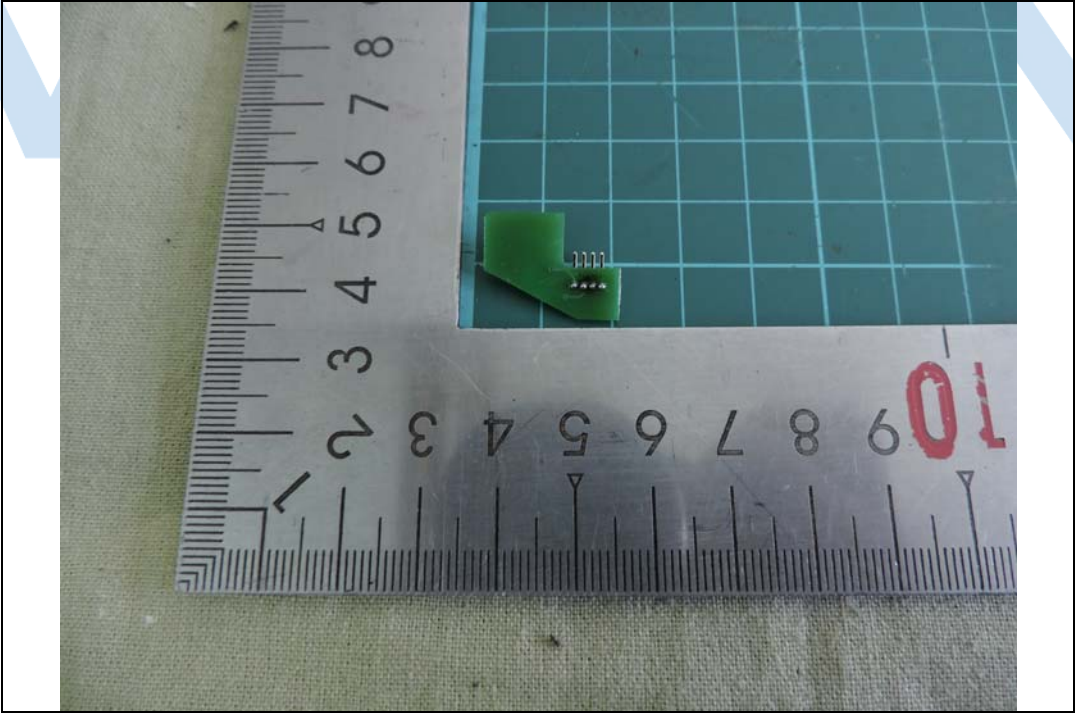

2.7.14 EUT Sub Board3 Top

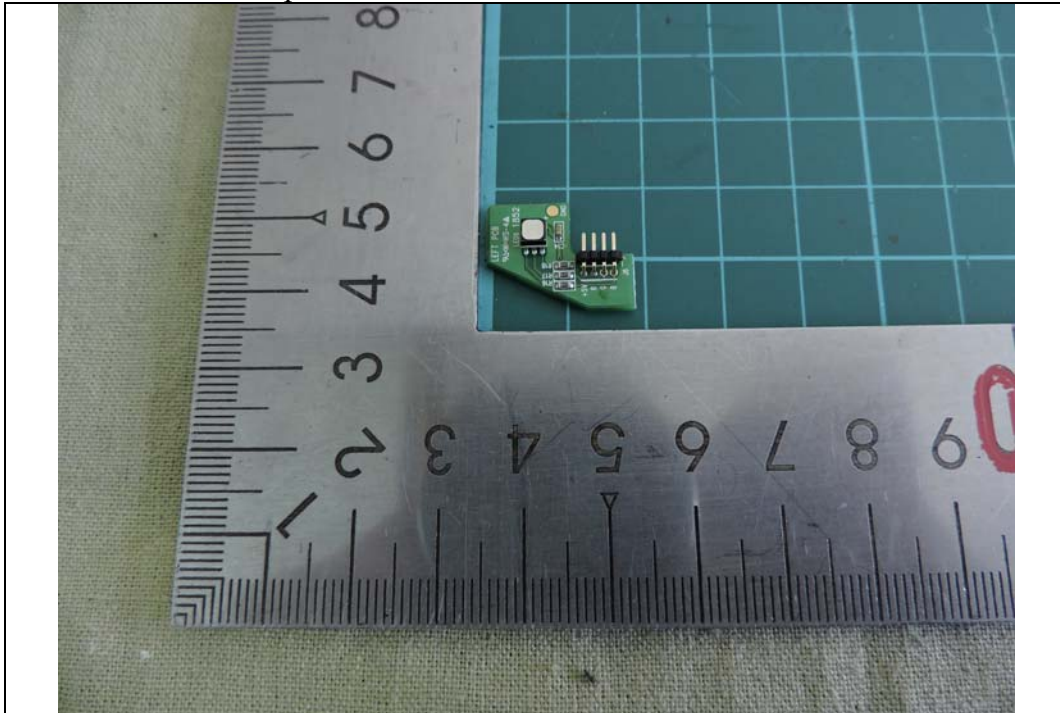

2.7.15 EUT Sub Board3 Bottom

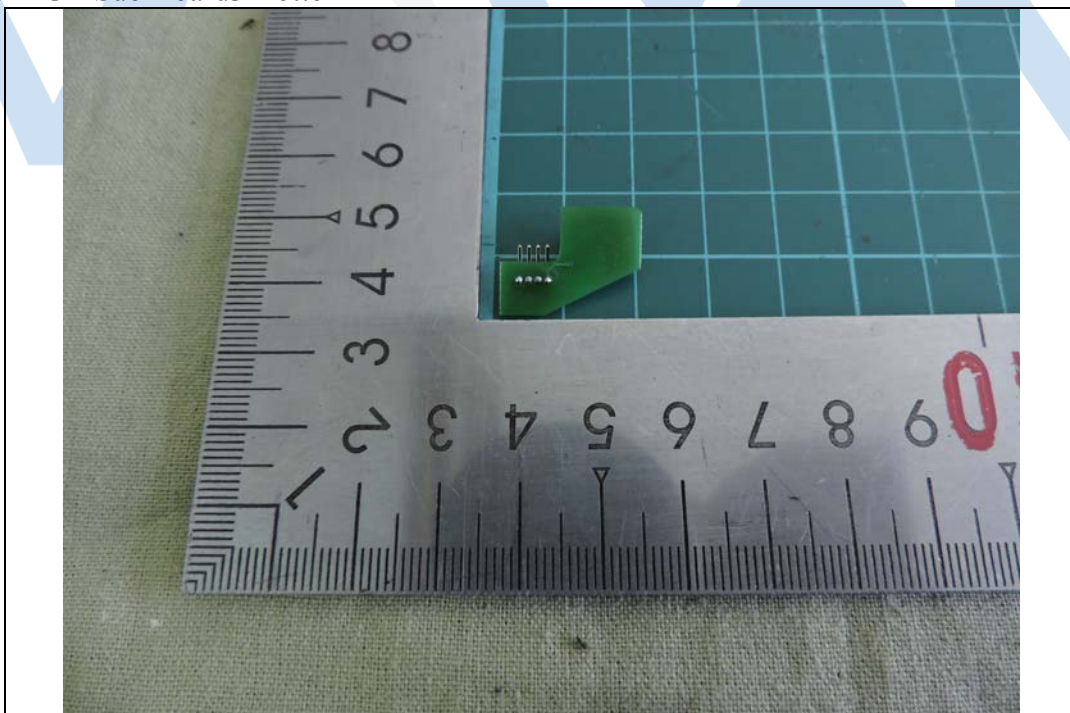

MOVON CORPORATION

Test Report No.: MOV-19-EMC-I035

2.7.16 EUT DC FAN Top



2.7.17 EUT DC FAN Bottom



MOVON CORPORATION

Test Report No.: MOV-19-EMC-I035

2.7.18 EUT Cigar jack



3 Test summary and results

Test Item	Requirement	Test Result
Radiated Emission (ALSE)	-	Meet the Requirement
Conducted Transient Immunity (Power line)	Class D	Class C
Conducted Transient Emission	-	Meet the Requirement

The results shown in this test report refer only to the sample(s) tested unless otherwise stated.

3.1 Radiated Emissions (ALSE)

3.1.1 Test Purpose

Measurement of radio disturbance which is emitted from the EUT.

3.1.2 Measurement equipment

Kind of Equipment	Manufacture / Model	S/N	Calibrated until
EMI TEST RECEIVER	ROHDE & SCHWARZ / ESR7	101922	2019.05.28
Artificial Network	ROHDE & SCHWARZ / ESH3-Z6	100642	2019.05.28
Artificial Network	ROHDE & SCHWARZ / ESH3-Z6	100643	2019.05.28
Biconical Antenna	ETS-Lindgren / 3110B	920253	2019.10.26
Logperiodic Antenna	ETS-Lindgren / 3148B	00118429	2019.10.26
Pre Amplifier	SONOMA INSTRUMENT / 310N	185428	2019.12.06
Software	ROHDE & SCHWARZ / EMC32	Version	N/A

3.1.3 Test conditions

Frequency band(MHz)	Broad band	Narrow band
	Quasi-Peak	Average
30 ~ 1 000	120 kHz	120 kHz

3.1.4 Test Set-up

3.1.4.1 Biconical Antenna

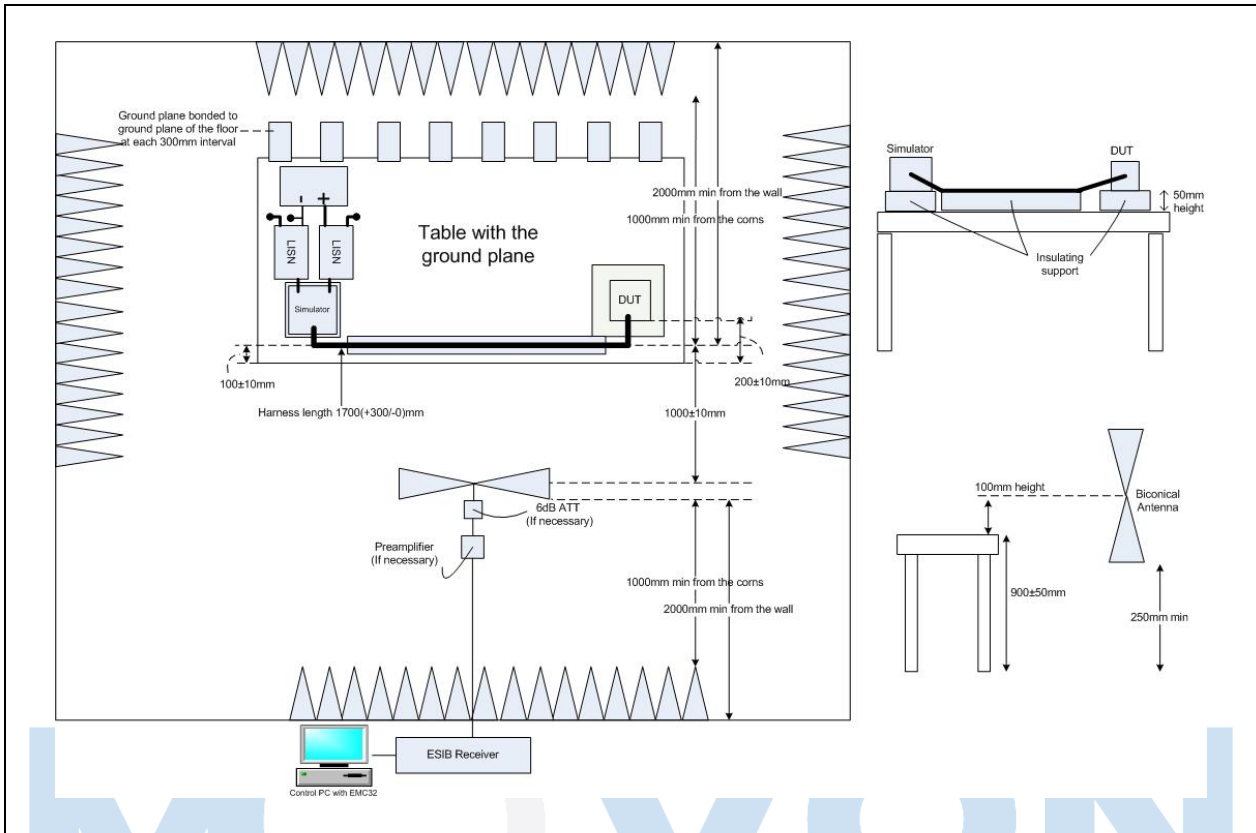

3.1.4.2 Photograph of Biconical Antenna

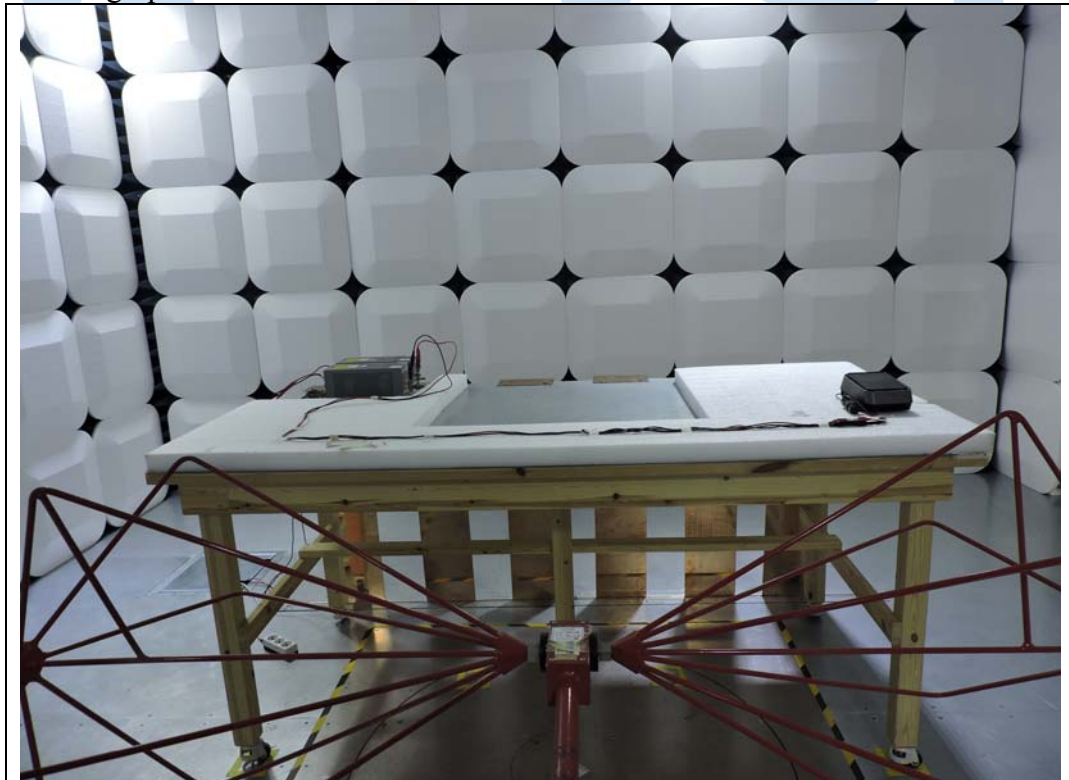

3.1.4.3 Log-periodic Antenna

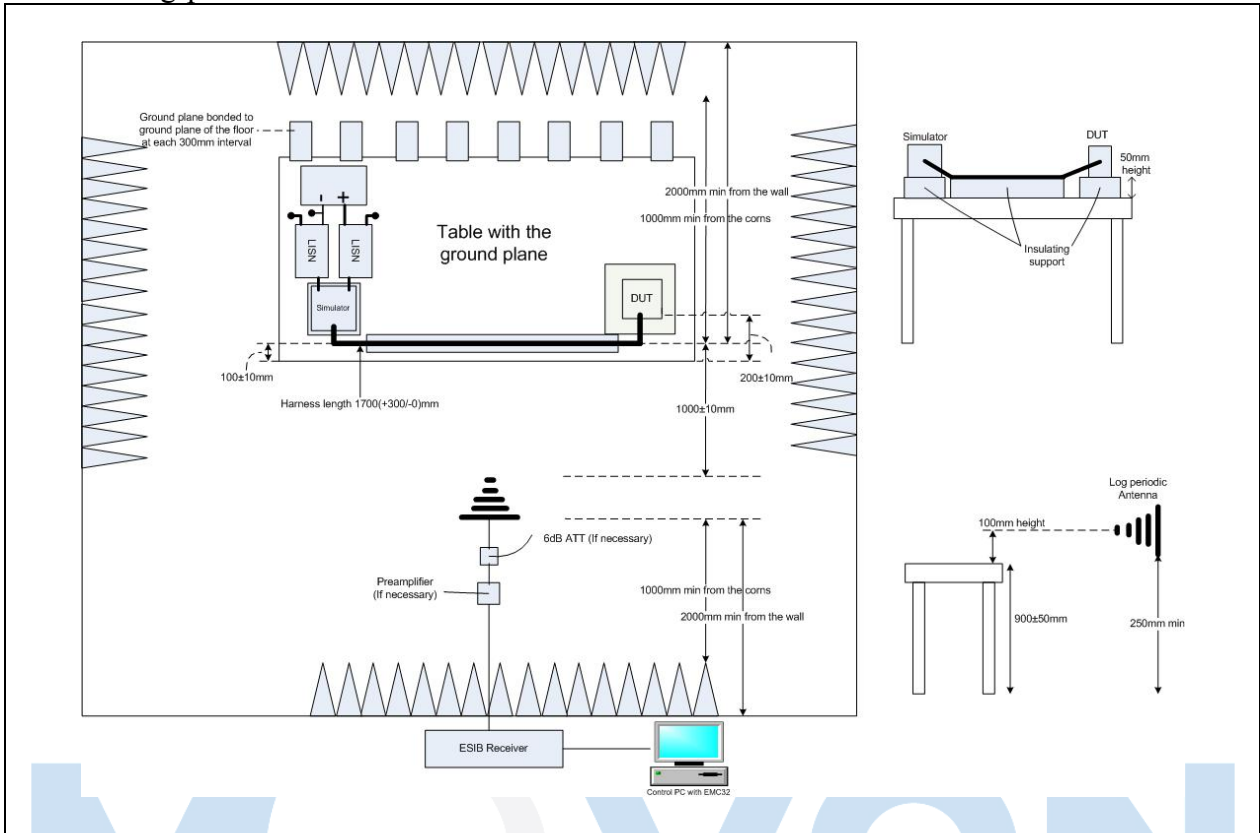

3.1.4.4 Photograph of Log-periodic Antenna

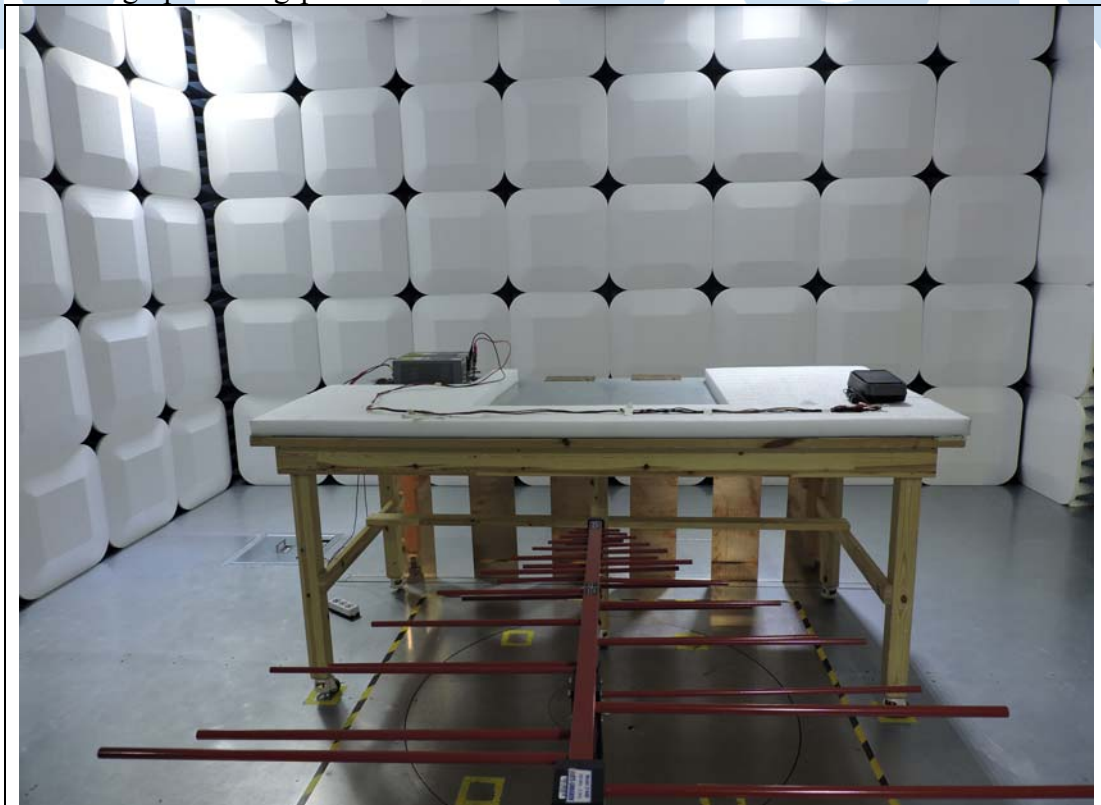

3.1.5 Environment Conditions

Test Date: 2019-01-15
Temperature: (18.2 ~ 18.3) °C
Humidity: 40.3 % R.H.
Atmospheric Pressure: 99.5 kPa

3.1.6 Test Results

Common Information

Test Description:	Radiated Emission Below 1GHz
Project No.:	0047-01-02/19
Test Site:	Chamber E
Model Name:	Bullstone air therapy smartaction
Test Mode:	Operating Mode
Polarizaion:	HORIZONTAL(Biconical Antenna)

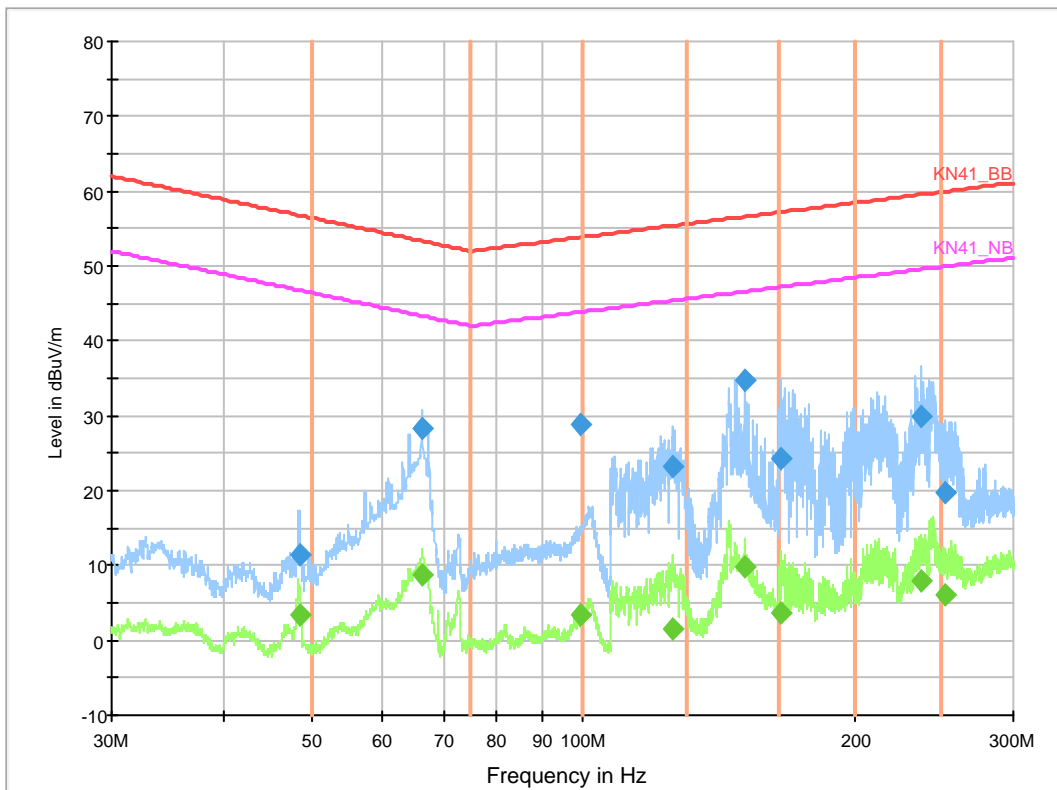

MOVON CORPORATION

Test Report No.: MOV-19-EMC-I035

Final Result 1

Frequency (MHz)	QuasiPeak (dBuV/m)	Meas. Time (ms)	Bandwidth (kHz)	Polarization	Corr. (dB)	Margin (dB)	Limit (dBuV/m)	Comment
48.414000	11.4	5000.0	120.000	H	-18.0	45.4	56.8	
66.288000	28.2	5000.0	120.000	H	-19.7	25.2	53.3	
99.498000	28.9	5000.0	120.000	H	-19.4	25.0	53.9	
125.688000	23.1	5000.0	120.000	H	-17.1	32.3	55.4	
150.906000	34.8	5000.0	120.000	H	-16.2	21.8	56.6	
165.918000	24.3	5000.0	120.000	H	-15.4	32.9	57.2	
237.360000	30.0	5000.0	120.000	H	-11.1	29.6	59.6	
252.453000	19.7	5000.0	120.000	H	-10.3	40.3	60.0	

Final Result 2

Frequency (MHz)	CAverage (dBuV/m)	Meas. Time (ms)	Bandwidth (kHz)	Polarization	Corr. (dB)	Margin (dB)	Limit (dBuV/m)	Comment
48.414000	3.4	5000.0	120.000	H	-18.0	43.4	46.8	
66.288000	8.9	5000.0	120.000	H	-19.7	34.5	43.3	
99.498000	3.5	5000.0	120.000	H	-19.4	40.3	43.9	
125.688000	1.4	5000.0	120.000	H	-17.1	44.0	45.4	
150.906000	9.9	5000.0	120.000	H	-16.2	36.7	46.6	
165.918000	3.6	5000.0	120.000	H	-15.4	43.7	47.2	
237.360000	7.8	5000.0	120.000	H	-11.1	41.7	49.6	
252.453000	6.0	5000.0	120.000	H	-10.3	44.0	50.0	



Common Information

Test Description:	Radiated Emission Below 1GHz
Project No.:	0047-01-02/19
Test Site:	Chamber E
Model Name:	Bullstone air therapy smartaction
Test Mode:	Operating Mode
Polarizaion:	VERTICAL(Biconical Antenna)

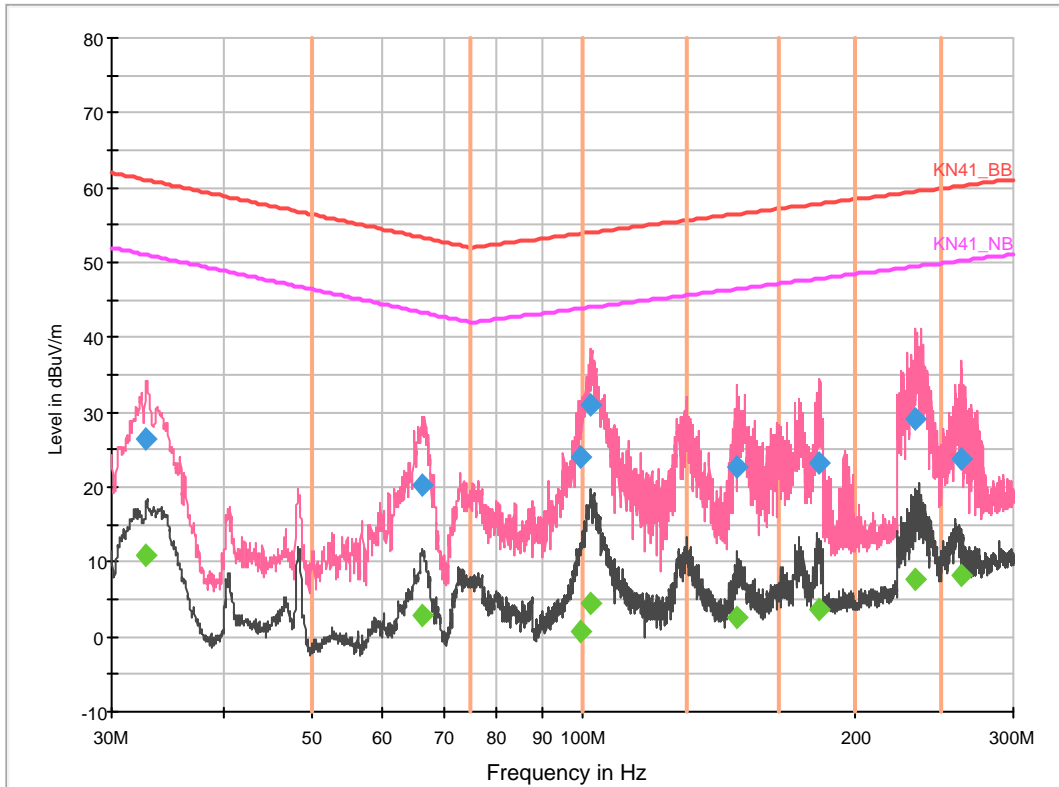

MOVON CORPORATION

Test Report No.: MOV-19-EMC-I035

Final Result 1

Frequency (MHz)	QuasiPeak (dBuV/m)	Meas. Time (ms)	Bandwidth (kHz)	Polarization	Corr. (dB)	Margin (dB)	Limit (dBuV/m)	Comment
32.808000	26.4	5000.0	120.000	V	-16.5	34.6	61.0	
66.315000	20.1	5000.0	120.000	V	-19.7	33.2	53.3	
99.390000	24.2	5000.0	120.000	V	-19.4	29.7	53.9	
102.036000	31.0	5000.0	120.000	V	-19.1	23.0	54.0	
147.801000	22.7	5000.0	120.000	V	-16.3	33.8	56.5	
183.063000	23.3	5000.0	120.000	V	-14.1	34.6	57.9	
233.040000	29.0	5000.0	120.000	V	-11.3	30.4	59.4	
262.065000	23.8	5000.0	120.000	V	-9.4	36.4	60.2	

Final Result 2

Frequency (MHz)	CAverage (dBuV/m)	Meas. Time (ms)	Bandwidth (kHz)	Polarization	Corr. (dB)	Margin (dB)	Limit (dBuV/m)	Comment
32.808000	11.0	5000.0	120.000	V	-16.5	40.1	51.0	
66.315000	2.7	5000.0	120.000	V	-19.7	40.6	43.3	
99.390000	0.8	5000.0	120.000	V	-19.4	43.1	43.9	
102.036000	4.4	5000.0	120.000	V	-19.1	39.7	44.0	
147.801000	2.5	5000.0	120.000	V	-16.3	43.9	46.5	
183.063000	3.7	5000.0	120.000	V	-14.1	44.1	47.9	
233.040000	7.5	5000.0	120.000	V	-11.3	41.9	49.4	
262.065000	8.3	5000.0	120.000	V	-9.4	41.9	50.2	



MOVON CORPORATION

Test Report No.: MOV-19-EMC-I035

Common Information

Test Description:	Radiated Emission Below 1GHz
Project No.:	0047-01-02/19
Test Site:	Chamber E
Model Name:	Bullstone air therapy smartaction
Test Mode:	Operating Mode
Polarizaion:	HORIZONTAL(Logperiodic Antenna)

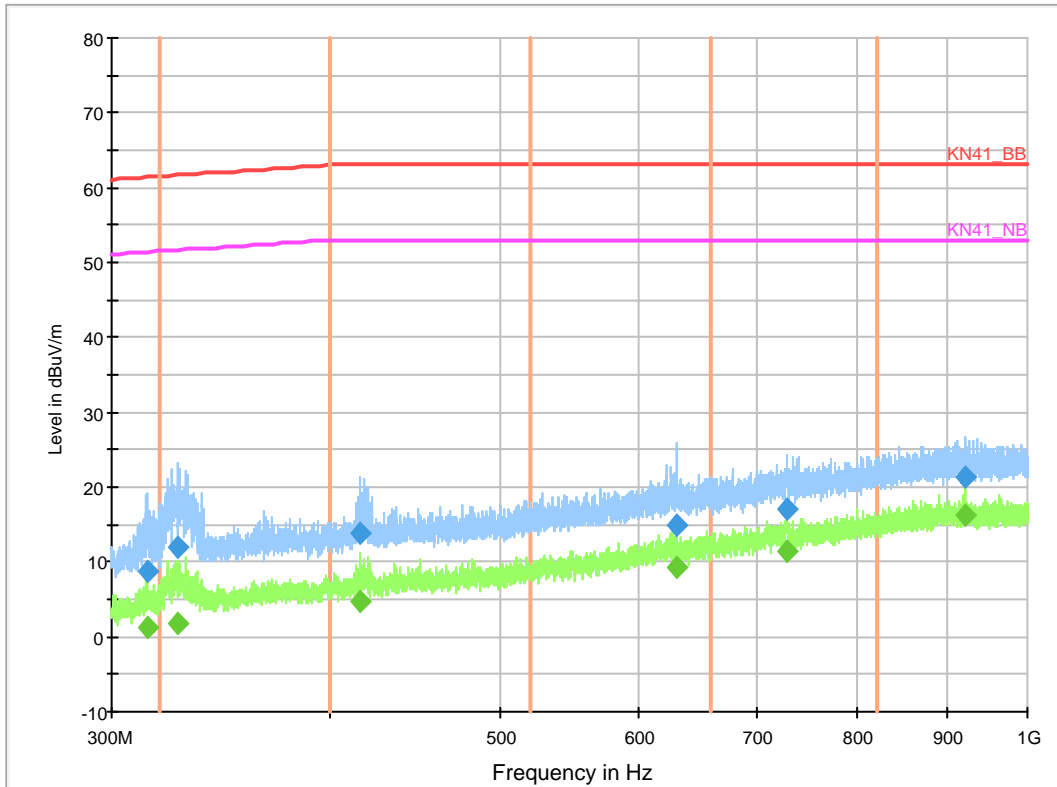

MOVON CORPORATION

Test Report No.: MOV-19-EMC-I035

Final Result 1

Frequency (MHz)	QuasiPeak (dBuV/m)	Meas. Time (ms)	Bandwidth (kHz)	Polarization	Corr. (dB)	Margin (dB)	Limit (dBuV/m)	Comment
314.175000	8.7	5000.0	120.000	H	-14.6	52.7	61.4	
326.950000	11.9	5000.0	120.000	H	-14.2	49.8	61.7	
415.605000	13.9	5000.0	120.000	H	-11.5	49.1	63.0	
630.365000	14.9	5000.0	120.000	H	-7.0	48.1	63.0	
729.205000	17.1	5000.0	120.000	H	-5.3	45.9	63.0	
922.090000	21.4	5000.0	120.000	H	-1.9	41.6	63.0	

Final Result 2

Frequency (MHz)	CAverage (dBuV/m)	Meas. Time (ms)	Bandwidth (kHz)	Polarization	Corr. (dB)	Margin (dB)	Limit (dBuV/m)	Comment
314.175000	1.3	5000.0	120.000	H	-14.6	50.1	51.4	
326.950000	1.9	5000.0	120.000	H	-14.2	49.8	51.7	
415.605000	4.7	5000.0	120.000	H	-11.5	48.3	53.0	
630.365000	9.2	5000.0	120.000	H	-7.0	43.8	53.0	
729.205000	11.5	5000.0	120.000	H	-5.3	41.5	53.0	
922.090000	16.3	5000.0	120.000	H	-1.9	36.7	53.0	



MOVON CORPORATION

Test Report No.: MOV-19-EMC-I035

Common Information

Test Description:	Radiated Emission Below 1GHz
Project No.:	0047-01-02/19
Test Site:	Chamber E
Model Name:	Bullstone air therapy smartaction
Test Mode:	Operating Mode
Polarizaion:	VERTICAL(Logperiodic Antenna)

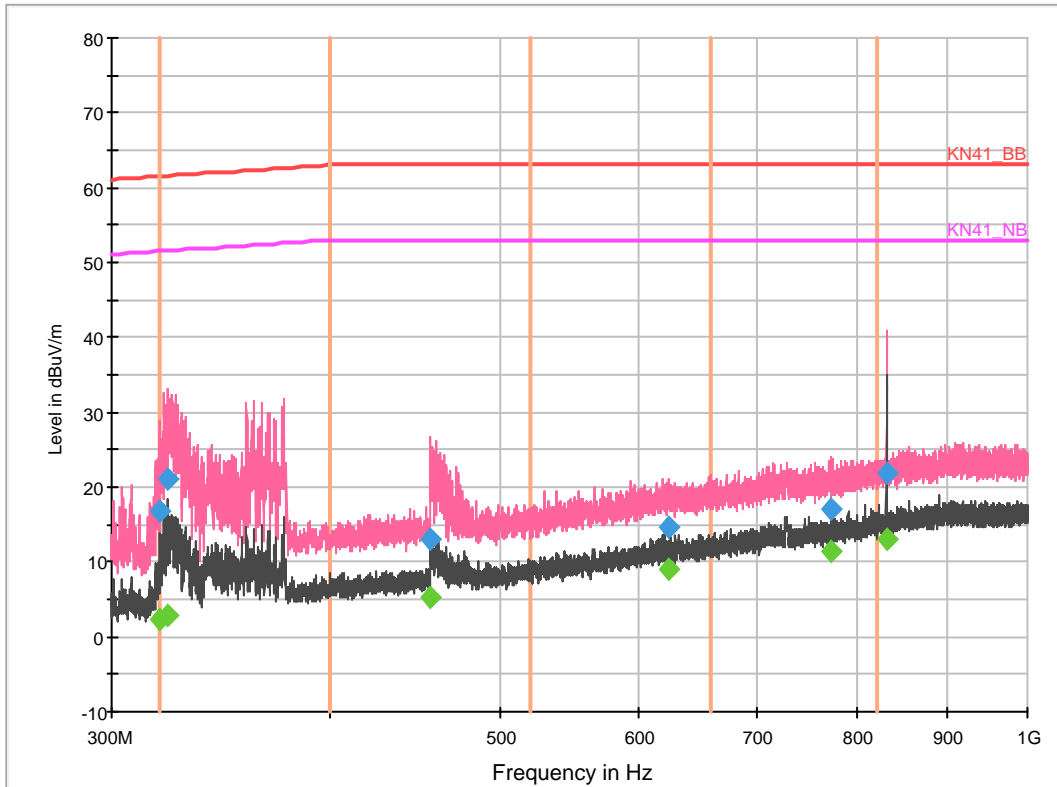

MOVON CORPORATION

Test Report No.: MOV-19-EMC-I035

Final Result 1

Frequency (MHz)	QuasiPeak (dBuV/m)	Meas. Time (ms)	Bandwidth (kHz)	Polarization	Corr. (dB)	Margin (dB)	Limit (dBuV/m)	Comment
319.775000	16.8	5000.0	120.000	V	-14.4	44.7	61.5	
323.275000	21.0	5000.0	120.000	V	-14.3	40.6	61.6	
456.240000	13.1	5000.0	120.000	V	-10.8	49.9	63.0	
623.400000	14.6	5000.0	120.000	V	-7.0	48.4	63.0	
772.675000	17.2	5000.0	120.000	V	-4.5	45.8	63.0	
830.635000	21.8	5000.0	120.000	V	-3.3	41.2	63.0	

Final Result 2

Frequency (MHz)	CAverage (dBuV/m)	Meas. Time (ms)	Bandwidth (kHz)	Polarization	Corr. (dB)	Margin (dB)	Limit (dBuV/m)	Comment
319.775000	2.2	5000.0	120.000	V	-14.4	49.3	51.5	
323.275000	2.9	5000.0	120.000	V	-14.3	48.7	51.6	
456.240000	5.2	5000.0	120.000	V	-10.8	47.8	53.0	
623.400000	9.1	5000.0	120.000	V	-7.0	44.0	53.0	
772.675000	11.5	5000.0	120.000	V	-4.5	41.5	53.0	
830.635000	13.1	5000.0	120.000	V	-3.3	39.9	53.0	



MOVON CORPORATION

Test Report No.: MOV-19-EMC-I035

3.2 Conducted Transient Immunity

3.2.1 Test Purpose

Measurement of immunity against conducted transient.

3.2.2 Measurement equipment

Kind of Equipment	Manufacture / Model	S/N	Calibrated until
Transient generator	EM Test / UCS 200N50	P1308113166	2019.12.06
Power Supply	EM Test / VDS 200N30	P1311114887	2019.12.06

3.2.3 Test conditions (Power line)

Pulse No.	Level (12 V)	Level (24 V)	Pulse/Time
1	- 75 V	- 450 V	5 000 pulses
2a	+ 37 V	+ 37 V	5 000 pulses
2b	+ 10 V	+ 20 V	10 pulses
3a	- 112 V	- 150 V	1 h
3b	+ 75 V	+ 150 V	1 h
4	- 6 V	- 12 V	1 pulse

3.2.4 Requirement

Test pulse number	Immunity test level	Functional status
1	III	D
2a	III	D
2b	III	D
3a	III	D
3b	III	D
4	III	D

Functional status D is where one or more functions of the ESA do not perform as designed during and after exposure and do not return to normal operation until exposure is removed and the ESA is reset by simple "operator/use" action.

3.2.5 Test Set-up

3.2.5.1 Conducted Transient Immunity (Power line)

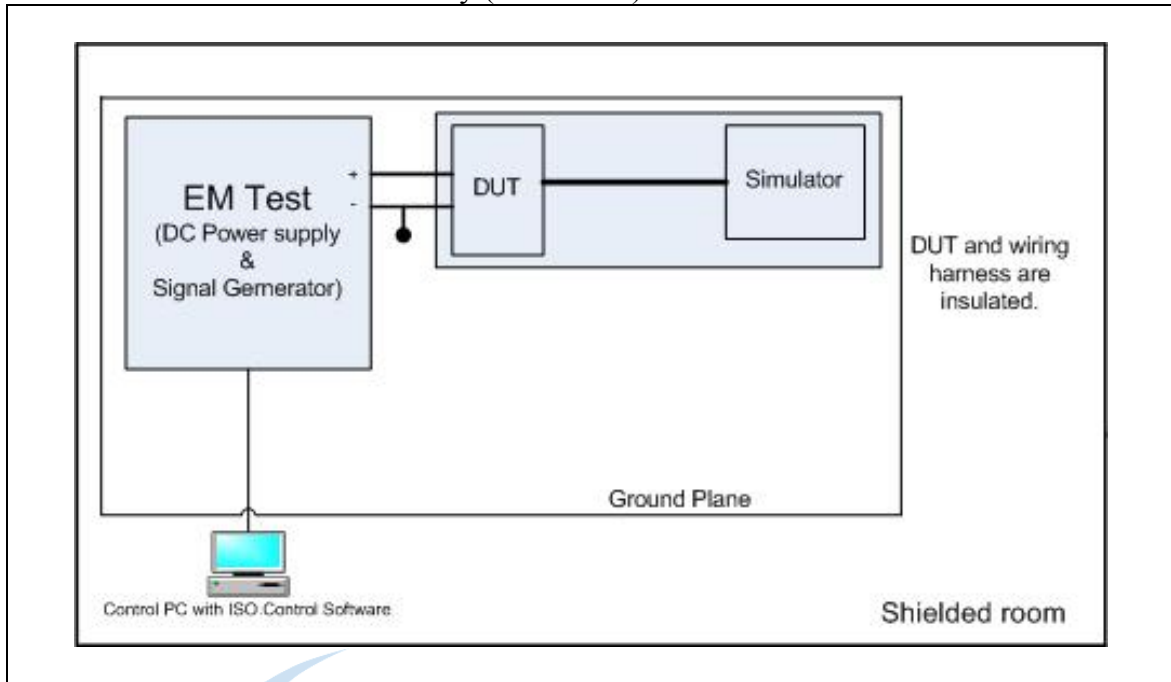

3.2.5.2 Photograph of Conducted Transient Immunity (Power line)



3.2.6 Environment Conditions

Test Date: 2019-01-23
 Temperature: (19.4 ~ 19.6) °C
 Humidity: (37.6 ~ 37.8) % R.H.
 Atmospheric Pressure: 99.4 kPa

3.2.7 Test Results

EUT	Mode	Pulse No.	Class	Results
(12 V)	1	1	Class C	During test : EUT off/on After test : Return to test mode automatically
		2a	Class A	No deviation
		2b	Class C	During test : EUT off/on After test : Return to test mode automatically
		3a	Class A	No deviation
		3b	Class A	No deviation
		4	Class C	During test : EUT off/on After test : Return to test mode automatically



3.3 Conducted Transient Emission**3.3.1 Test Purpose**

Measurement of conducted emissions of transients from a EUT.

3.3.2 Measurement equipment

Kind of Equipment	Manufacture / Model	S/N	Calibrated until
ConductionTransient Voltage Test	EM Test /AN200	V0519100358	2019.12.07
Digital Phosphor Oscilloscope	Tektronix / DP03054	C010900	2019.05.28

3.3.3 Test conditions

Voltage Condition	Mode	Maximum allowed pulse amplitude (V)
12 V	Slow pulse	+ 75 V / - 100 V
	Fast pulse	
24 V	Slow pulse	+ 150 V / - 450 V
	Fast pulse	



3.3.4 Test setup
3.3.4.1 Slow Pulse

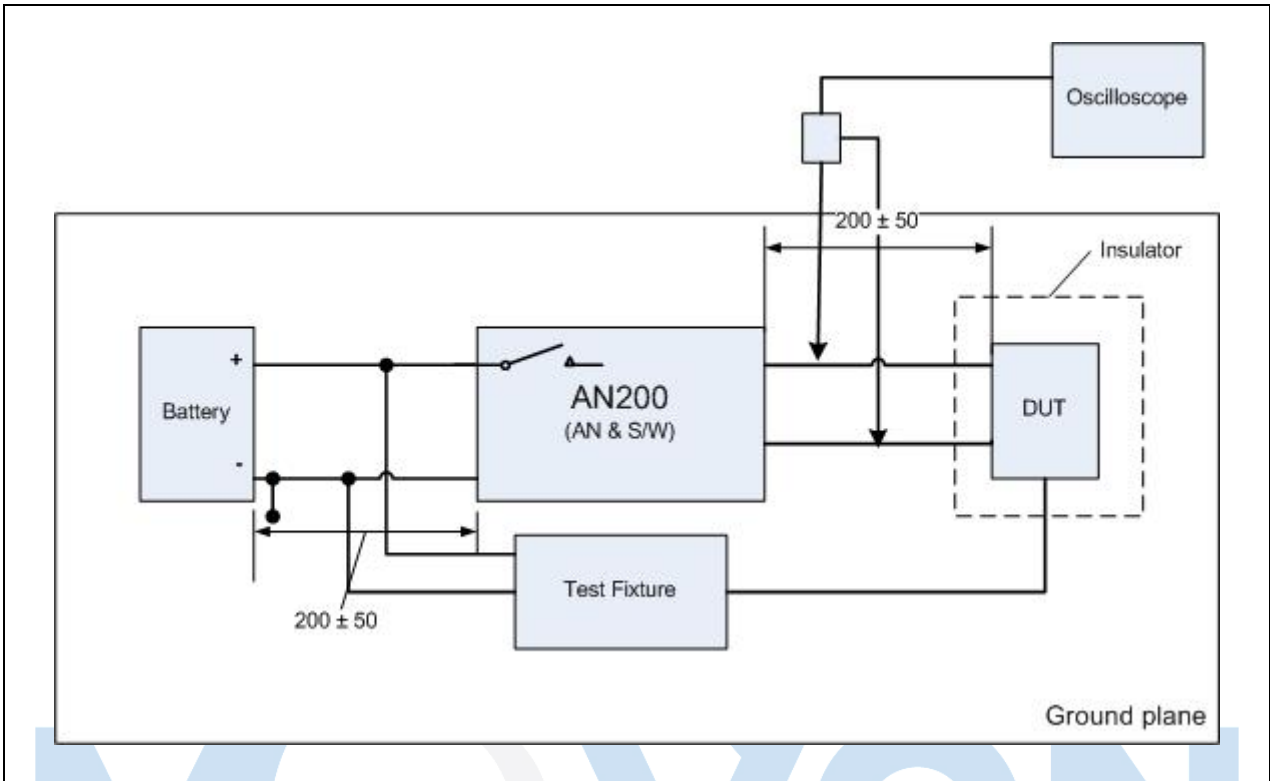

3.3.4.2 Fast Pulse

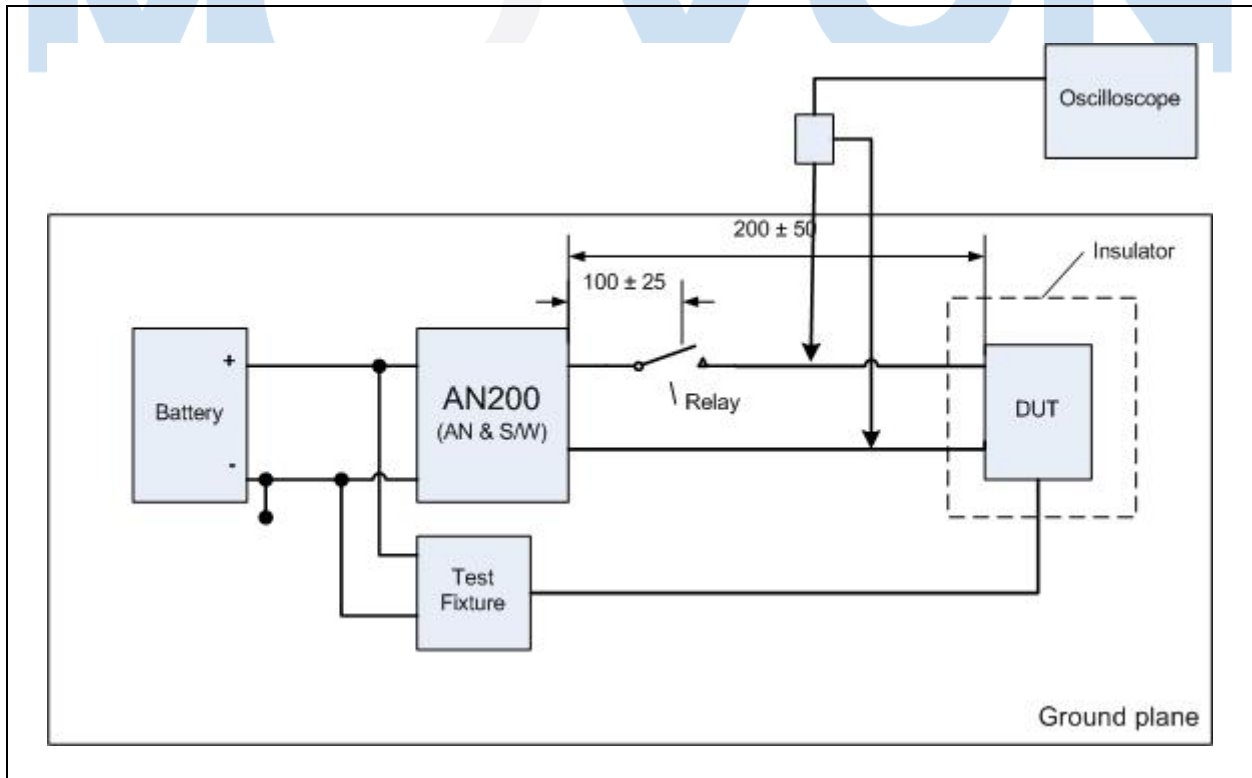

MOVON CORPORATION

Test Report No.: MOV-19-EMC-I035

3.3.4.3 Photograph of Conducted Transient Emission test (Fast Pulse)

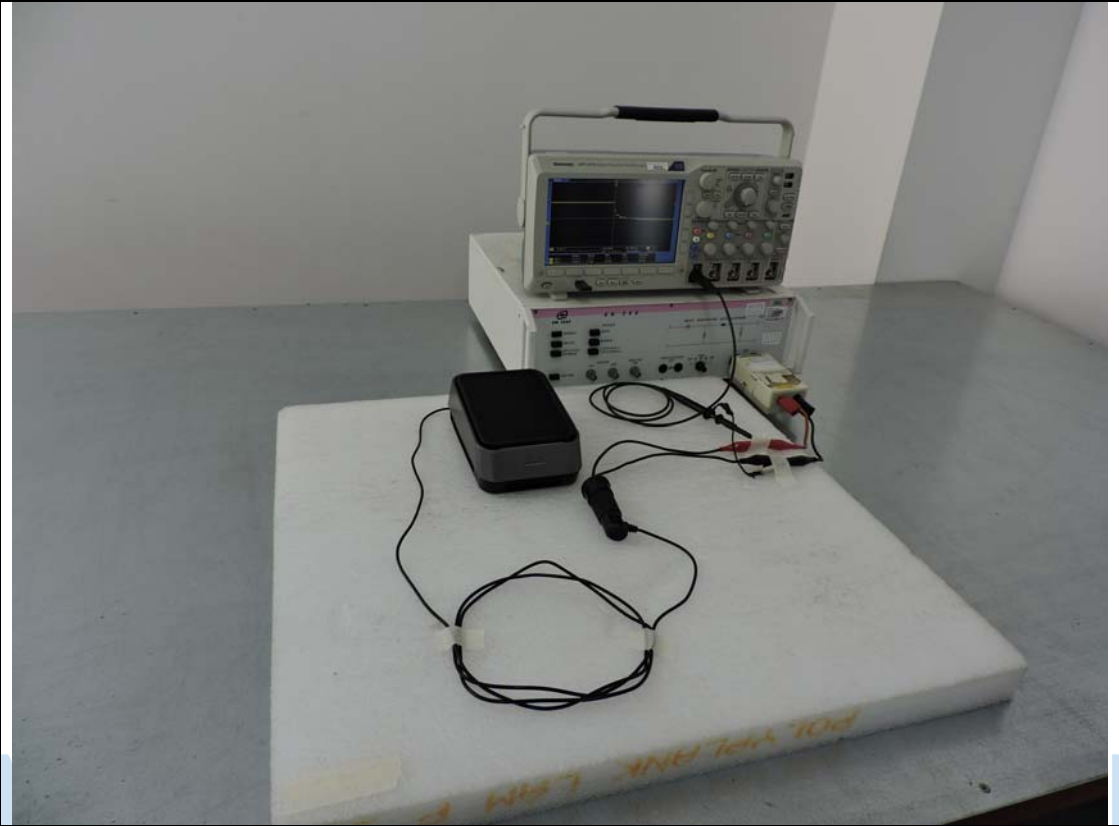

MOVON CORPORATION

Test Report No.: MOV-19-EMC-I035

3.3.5 Environment Conditions

Test Date: 2019-01-24

Temperature: 17.7 °C

Humidity: 39.3 % R.H.

Atmospheric Pressure: 99.1 kPa

3.3.6 Test results

Voltage condition	Mode	Pulse amplitude	Requirement Level (V)	Max. Value(V)	Results
12 V	Slow	Positive	+ 75	+12.6	Compliant
		Negative	- 100	-0.8	Compliant
	Fast	Positive	+ 75	+12.4	Compliant
		Negative	- 100	+1.0	Compliant

- Compliant : The EUT met the requirements of EN50498:2010 in each sections.

- Non-compliant : The EUT didn't meet the requirements of EN50498:2010 in each sections.

※ Supplements the conducted transient emission data to appendix C.



APPENDIX

A. Conducted Transient Immunity

1. Pulse 1

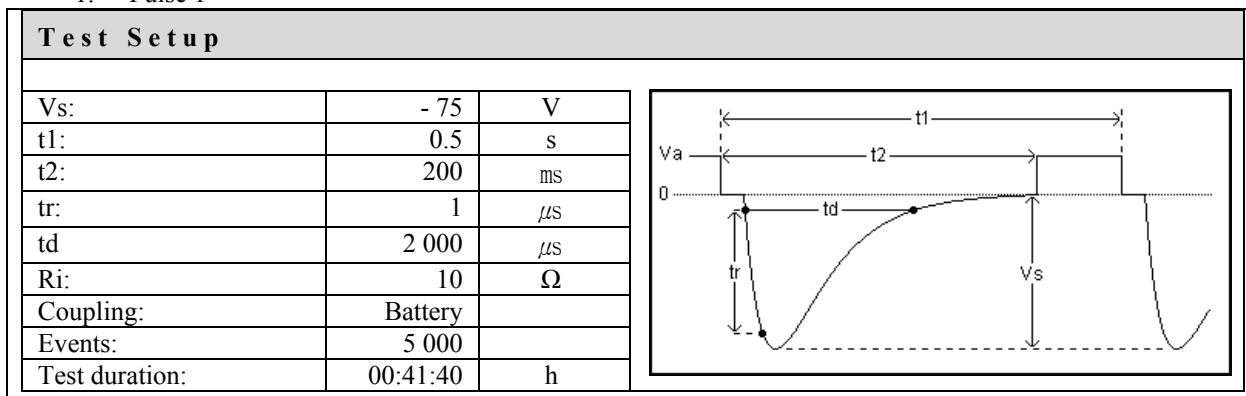

2. Pulse 2a

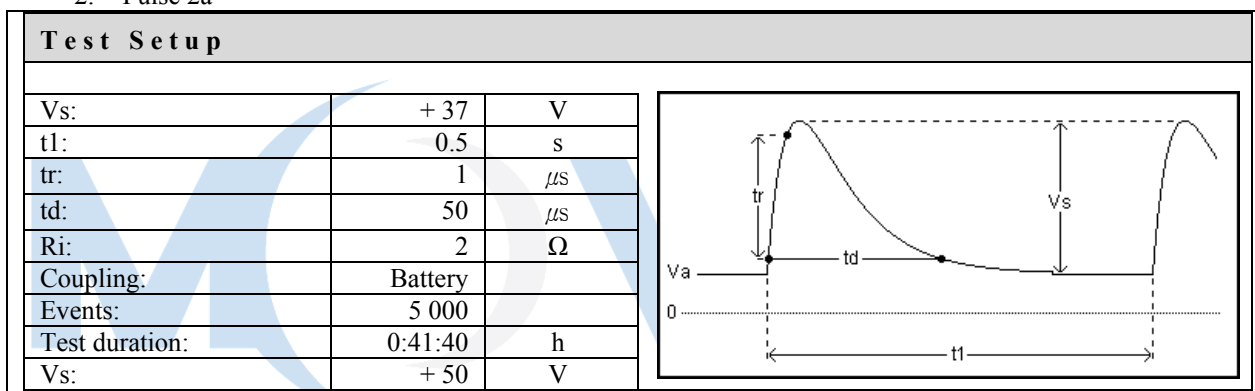

3. Pulse 2b

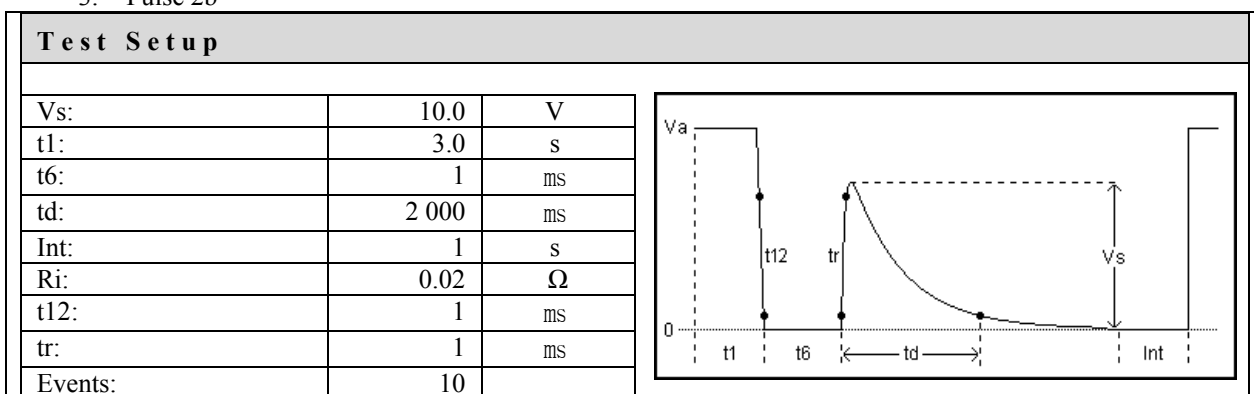

4. Pulse 3a

Test Setup		
Vs:	- 112	V
f1:	10	kHz
t4:	0	ms
t5:	90	ms
tr:	5	ns
td:	100	ns
Ri:	50	Ω
Coupling:	Battery	
Test duration:	1	h

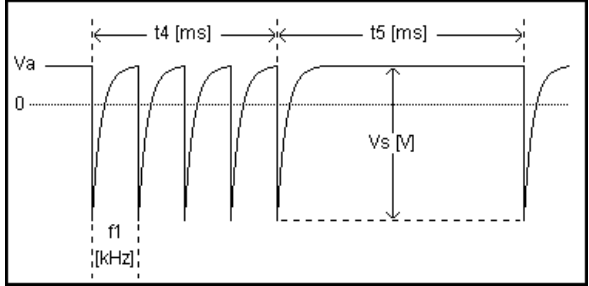

5. Pulse 3b

Test Setup		
Vs	+ 75	V
f1:	10	kHz
t4:	10	ms
t5:	90	ms
tr:	5	ns
td:	100	ns
Ri:	50	Ω
Coupling:	Battery	
Test duration:	1	h

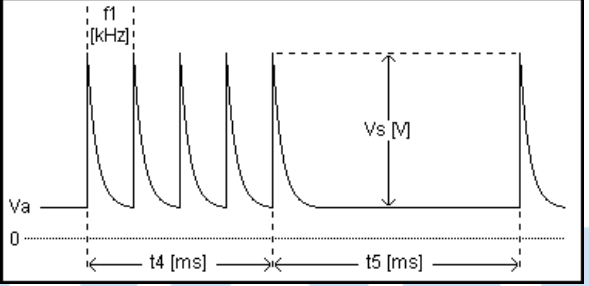

6. Pulse 4

Test Setup		
Va1:	- 6	V
Va2:	- 2.5	V
t1:	1.0	s
t6:	5	ms
t7:	40	ms
t8:	50	ms
t9:	20	s
t11:	100	ms
Events:	1	
Test duration:	00:00:22	h

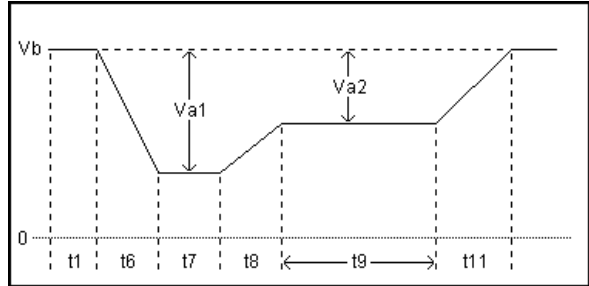

B. Conducted Transient Emission

1. Fast mode (on-off) [DC 12 V]

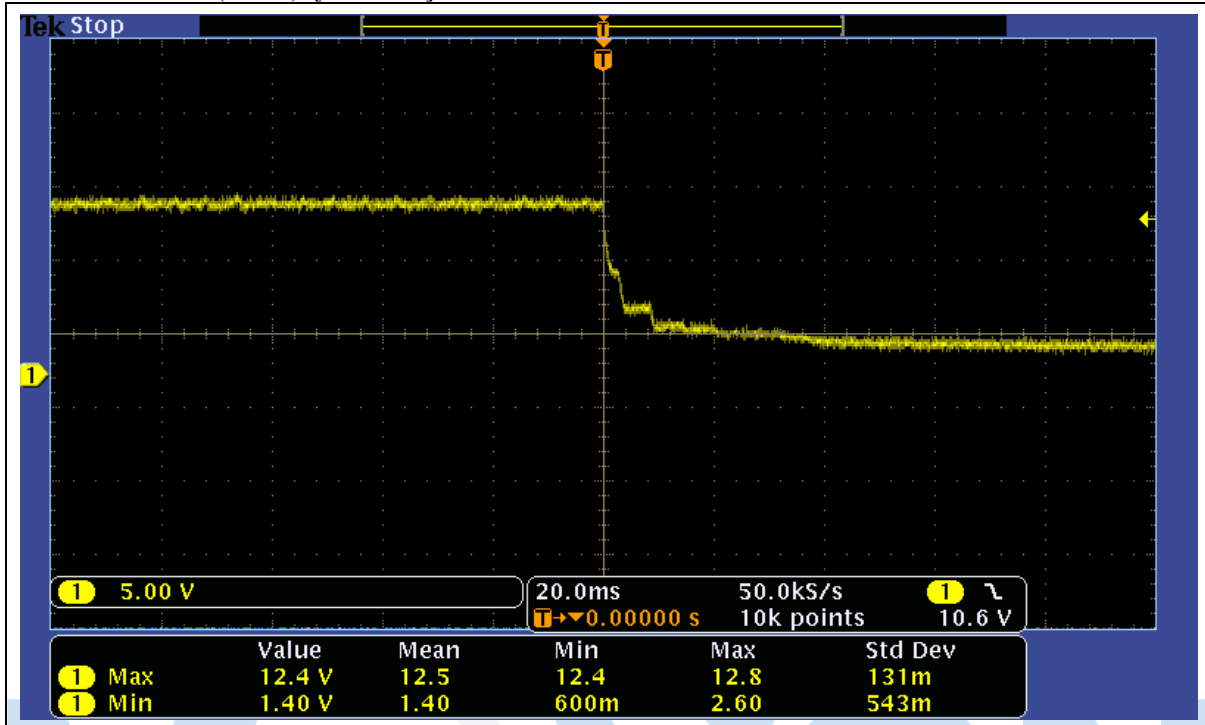

2. Fast mode (off-on) [DC 12 V]

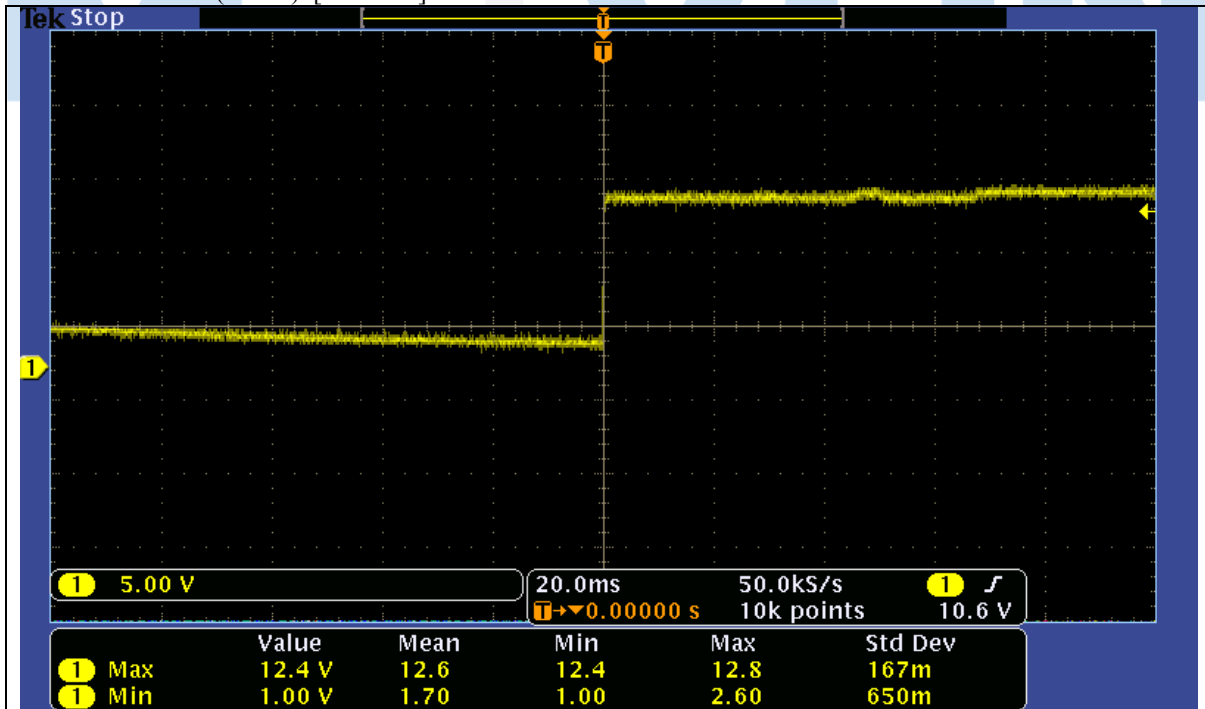

3. Slow mode (on-off) [DC 12 V]

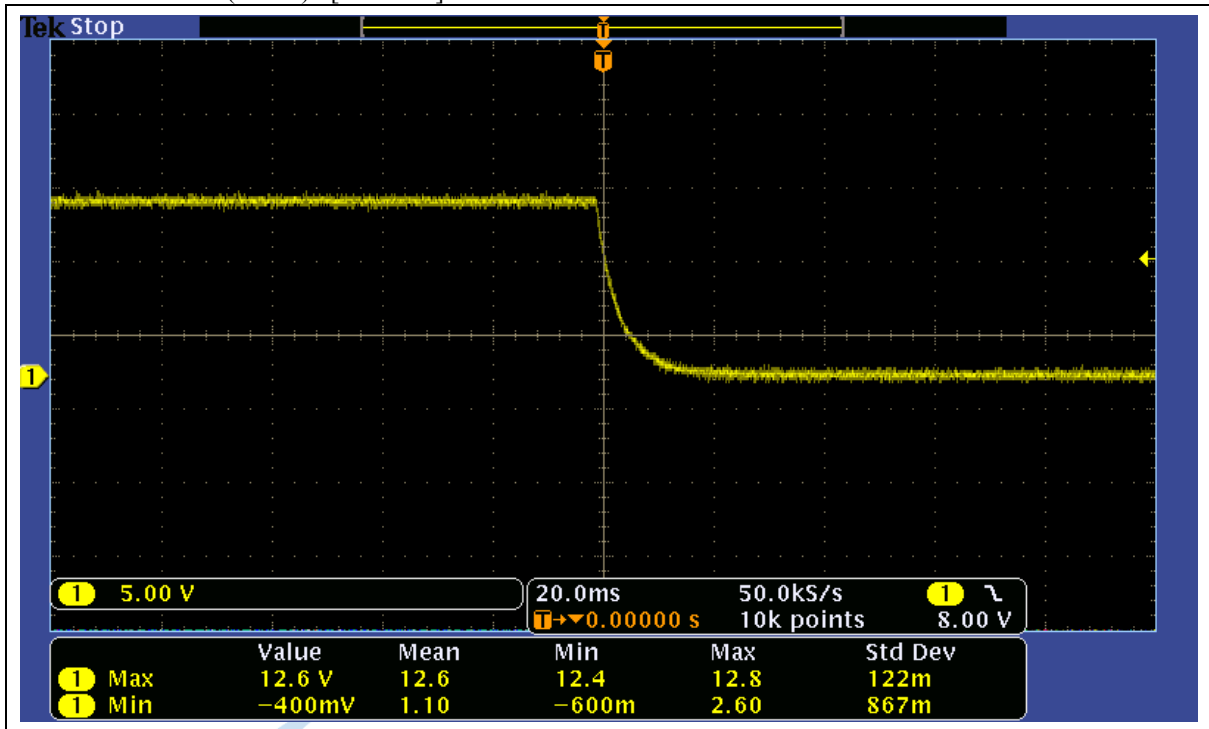

4. Slow mode (off-on) [DC 12 V]

